

Max Snap Stand™ ***Operating Instructions***

max *Snap*
Stand™



Contents

Setting up your Max Snap Stand	2
Installing a Brake on your Max Snap Stand	2-3
Removing Brake from Max Snap Stand	3
Counter Balance Step Assembly Instructions.....	4

Setting up your Max Snap Stand™



Figure 1A

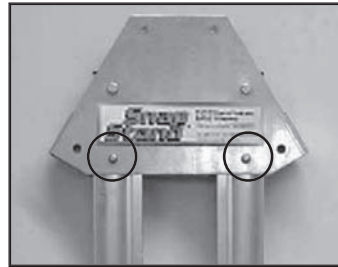

Snap Button locations when legs are closed.

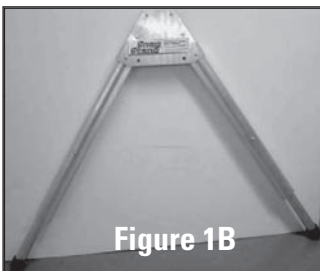
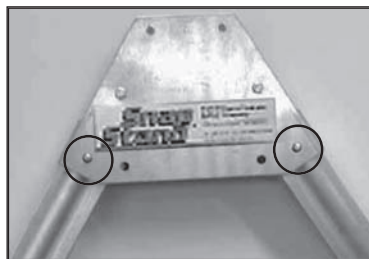

Figure 1B



Snap Button locations when legs are open.

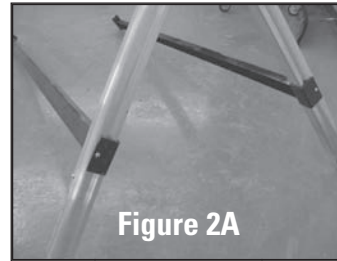

Figure 2A

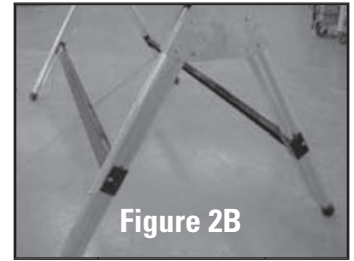

Figure 2B

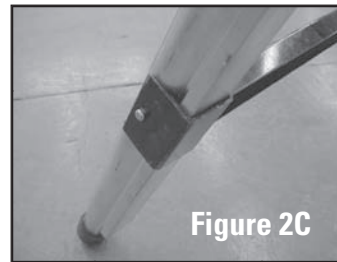

Figure 2C

STEP 1

To open each Leg Set, push in on the snap button and move each leg outward to the working position. Figure 1A above shows the leg set as shipped while Figure 1B shows the leg set open (working position). Make sure button snaps out to lock each leg.

STEP 2

Attach the Cross Braces to the Leg Sets. With the snap button of the Leg Set pointing to the outside, snap the Cross Braces into position. See Figures 2A and 2B above.

Be sure the C-shape of the Cross Brace is mating the leg as shown in Figure 2C above.

Installing a Brake on Max Snap Stand™

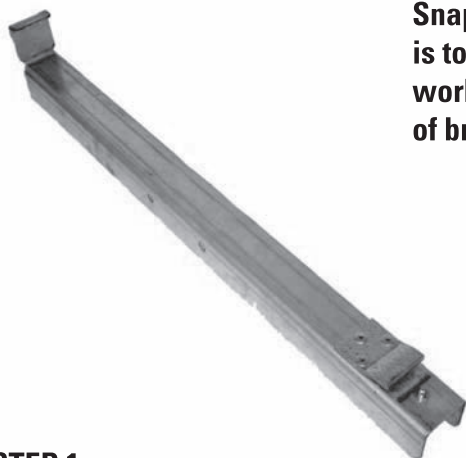

Snap button is toward the working side of brake

STEP 1

Using the 1/4-20 bolts and lock washers provided, fasten the brake mounts to the Leg Set.

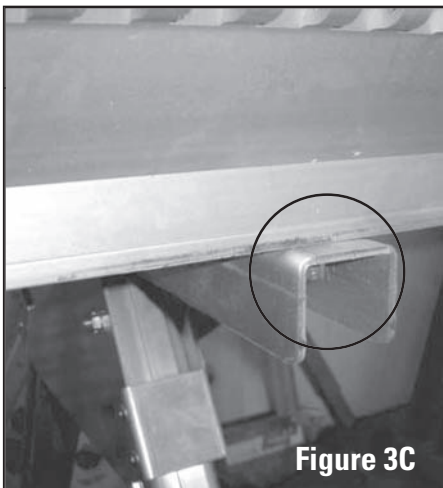
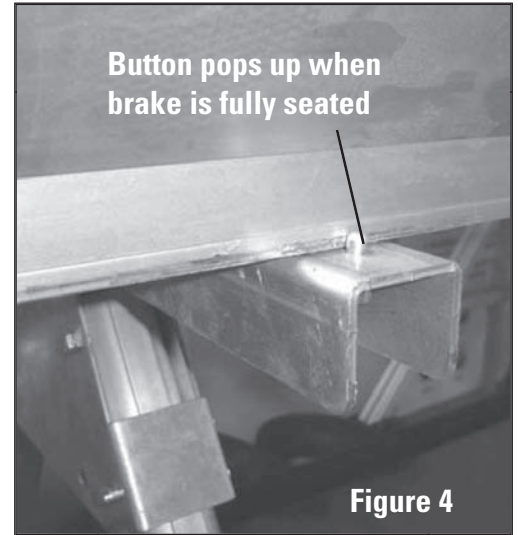
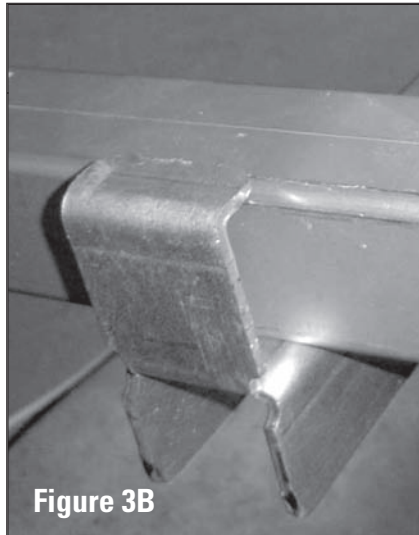

Figure 2

STEP 2

The snap button will be toward the working side of the brake. Repeat Step 1 for the other Leg Set. Be sure that both ends of the Snap Stand are going the same direction (with the snap buttons on the same side). See Figure 2 at left.

Installing a Max Brake on Max Snap Stand™



STEP 3
Place the brake on the assembled Snap Stand with the Back Rail of the brake clearing the adaptor hook as shown in Figures 3A and 3B above.

The snap button will be covered by the fixed hinge of the brake as in Figure 3C above.

STEP 4
Push the brake firmly rearward into the adaptor hooks. The snap buttons by the front clips will pop up and secure the brake on the Snap Stand. See Figure 4 above.

Counter Balance is required for operation. See installation instructions on page 4.

Removing a Brake from Max Snap Stand™

- Removing the brake from the Snap Stand is essentially the opposite of attaching it to the stand.
- Lifting the Moving Hinge, depress the snap button and pull the brake forward far enough to hold each snap button down.
- Be sure the box rail is out of the Rear Clip. The brake can now be removed from the stand.
- Reverse Steps 2 and 1 to disassemble the stand for transport.

Counter Balance Assembly Instructions

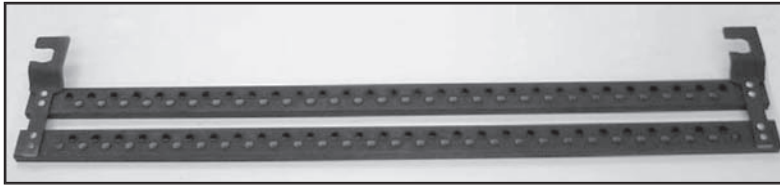

Connector

Figure 5

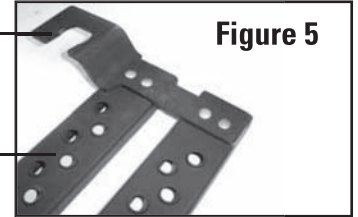

Step

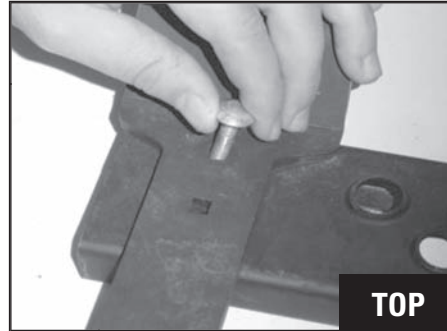

STEP 1

Attach the Connectors to the Steps using the carriage bolts and nuts provided. The square portion of the carriage bolt will fall into the square holes that are punched in the Connector. Tighten securely using a 7/16" wrench. See figure 5 above for Connector orientation.

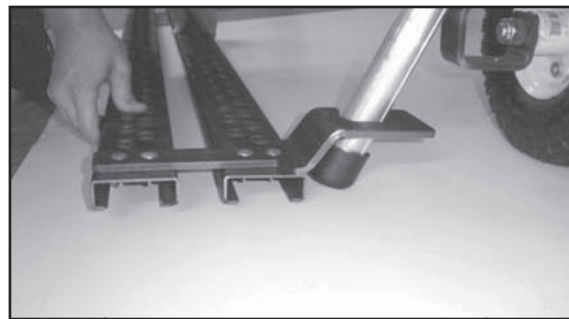
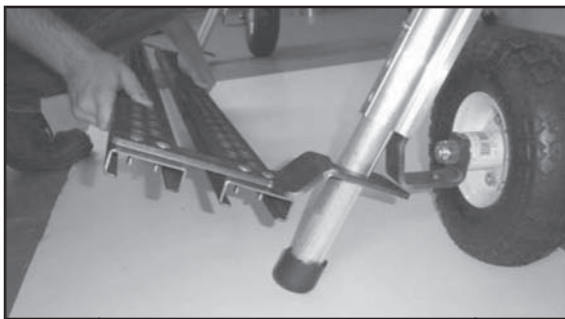

STEP 2

To attach the Step Assembly to the Snap Stand, hold the assembly at an angle as shown and slide both connectors leftward over both legs of the Snap Stand as far as they will go. Allow the connectors to slip down the legs until the steps are flat and touching the ground. The connectors should be gripping the front and back of each leg. Standing on the steps while bending will lock the connectors in place on the legs.

Removal is the reverse of assembly. Lift up on the steps to release them from the legs, and slide the assembly to the right until the connectors are free of the legs.

TAPCO PRODUCTS COMPANY

A Division of Tapco International

29797 Beck Road • Wixom, MI 48393-2834
phone: (800) 521-7567 • www.tapcoint.com