

SturdiMount



Fiber Cement Mounting Blocks

SturdiMount.com

SAVE TIME IMPROVE YOUR PROJECT

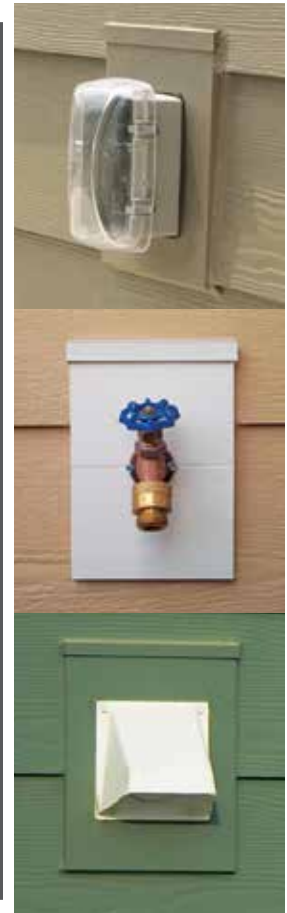

Receptacle Mount

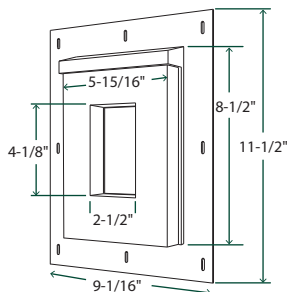

Part #:	SMR68**
Qty:	5 per box
Size:	6" x 8-1/2"
Wgt:	7.5 lbs.
Use:	Electrical boxes

Split Mount

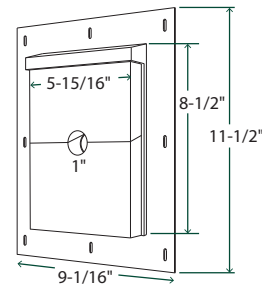

Part #:	SMS68**
Qty:	5 per box
Size:	6" x 8-1/2"
Wgt:	7.5 lbs.
Use:	Spigots, gas lines & door bells

Universal Mount



** Indicates color letters. Please see colors on back.

SturdiMount®

For the beauty you want and the water protection you need.

SturdiMount fiber cement blocks are manufactured using cellular PVC. Their engineered water management system maintains integrity with its innovative pre-flashed, pre-assembled design. The 13 color-matched colors provide a clean finished look you can't get anywhere else. Our Trim White can be left white or painted.

- Pre-flashed and pre-assembled for protection against water damage.
- Provides job site uniformity, no matter which crew sides the house.
- Saves time and labor, SturdiMount installs in seconds.
- Provides a clean and more finished look.
- For use on fiber cement, engineered wood, cedar and composite siding.
- Will not chalk or fade.
- The mounting surface is manufactured of cellular PVC.

For onsite customization blanks are available in **Universal, Oversized and Receptacle Profiles.**

(Flange is pre-cut)
Available in Trim White (TW) only.



Universal Part #: SMU811BTW4

Oversized Part #: SM0815BTW

Receptacle Part #: SMR68BTW

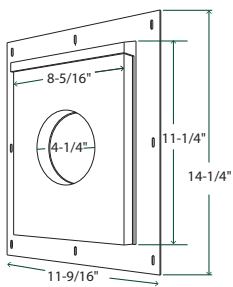

Part #: 3-5/8" Cut out
SMU3811TW4

Part #: **SMU811**4**

Qty: 5 per box

Size: 8-1/2" x 11"

Wgt: 11.7 lbs.

Use: Standard lights & dryer vents

Oversized Mount

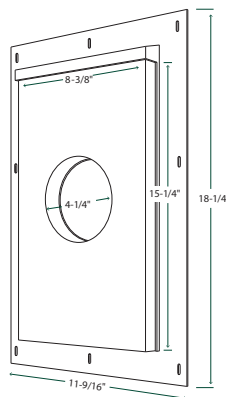

Part #: **SMO815****

Qty: 5 per box

Size: 8-1/2" x 15"

Wgt: 15.1 lbs.

Use: Coach lights

NEW UL Receptacle Mount

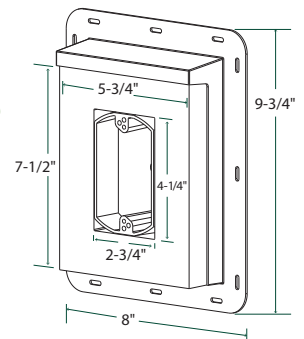

Part #: **SMRUL68TW**

Qty: 5 per box











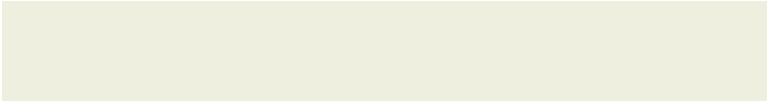

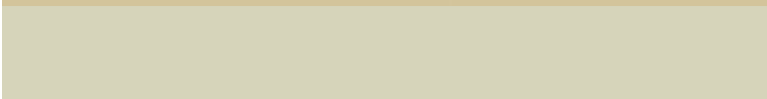
Size: 5-3/4" x 7-1/2"

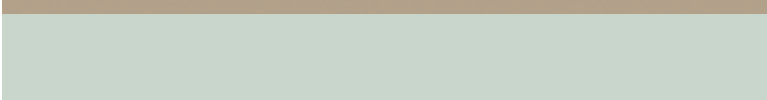
Wgt: 6.62 lbs.

Use: Standard lights & electrical boxes

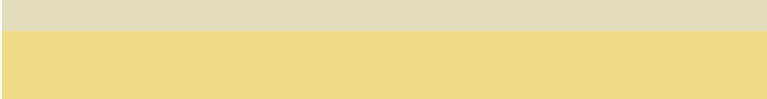
Available in Trim White (TW) only.

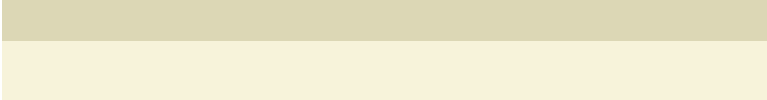
BLOCK COLOR PALETTE

	Arctic White (AW)
	Autumn Tan (AT)
	Cobble Stone (CS)
	Khaki Brown (KB)
	Light Mist (LM)
	Woodstock Brown (WB)
	Timber Bark (TB)
	Monterey Taupe (MT)
	Navajo Beige (NB)
	Woodland Cream (WC)
	Sandstone Beige (SB)
	Sail Cloth (SC)
	Trim White (TW)

Architectural drawings are now available:



Actual colors may vary from printed examples.

SturdiMount®

MidAmericaComponents.com
Customer Service: 800-521-8486
Fax: 888-459-3647



©2016 Tapco International Corporation
A Division of Headwaters



Item # 0008 8738 000
SM 4146 2/16